



DSCT Heat Shrinkable Stress Control Tubing

- Electrical Stress Control at the end of the cable shielding
- Suitable for underground buried Joint, Indoor & Outdoor termination
- Continuous operation temperature: -40°C to 125°C
- Meets the requirements of ESI 09 13
- Shrink Temperature: 120°C
- Unlimited shelf life

40
Years of
Experience

35
Countries
Global
Presence

200
Plus Skilled
Manpower

4
World Class
Manufacturing
Facilities

50
Internationally
Approved
Products

DENSONS Heat Shrinkable Terminations and Straight Joints offer unsurpassed technical superiority. Using state-of-the-art manufacturing technology. Densons High Voltage products provide maximum protection against Tracking, Corona Discharge and Dielectric Stresses. Densons High Voltage Products are easily adaptable to cover a broad range of cable sizes, and conforming to various Internationally accepted standards such as **IS, VDE, IEC, IEEE**.

Dimension Chart for Stress Control Tubing

Code	As Supplied		After Recovered
	ø D1 (max.)	ø D2 (max.)	T(min.)
DSCT - 15/30	15	30	2.5
DSCT - 20/45	20	45	2.8
DSCT - 25/50	25	50	3.0
DSCT - 30/65	30	65	3.0

Note: All Dimensions are in mm

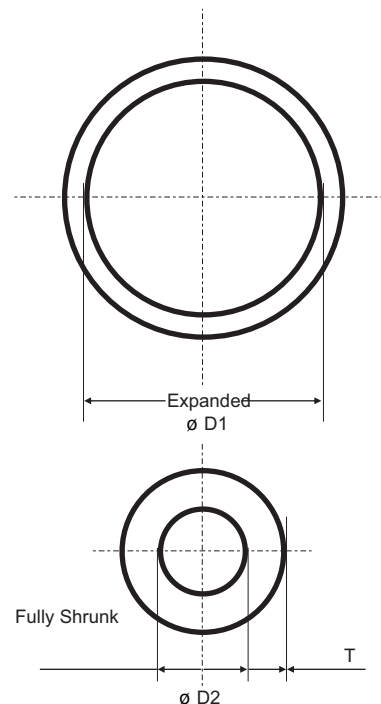

Technical Data:

Property	Requirements	Test Method
Physical		
Tensile Strength	10 N/mm ² (min.)	ASTM D 412 / ISO 37
Ultimate elongation	200% (min.)	ASTM D 412 / ISO 37
Water absorption (25°C)	0.5% (max.)	ASTM D 570
Thermal Ageing		
Continuous operating temperature	-55°C to +130°C	IEC 216
Shrink temperature	120°C (min.)	IEC 216
Heat shock (30 min. 200°C)	No cracking / No flowing	
Heat ageing (168 hrs 120°C)		
Tensile strength	8.0 N/mm ² (min.)	ASTM D 412 / ISO 37
Ultimate elongation	200% (min.)	
Low temperature flexibility (-20°C)	No cracking	ASTM D 2671
Electrical Properties		
Volume resistivity	1 x 10 ⁹ ohm-cm (min.)	ASTM D 257 / IEC 93
Dielectric constant	15 min.	ASTM D 150 / IEC 250